

Kett kinnitatakse kruvide külge ja see hoiab akent tuuleilide korral paigal.

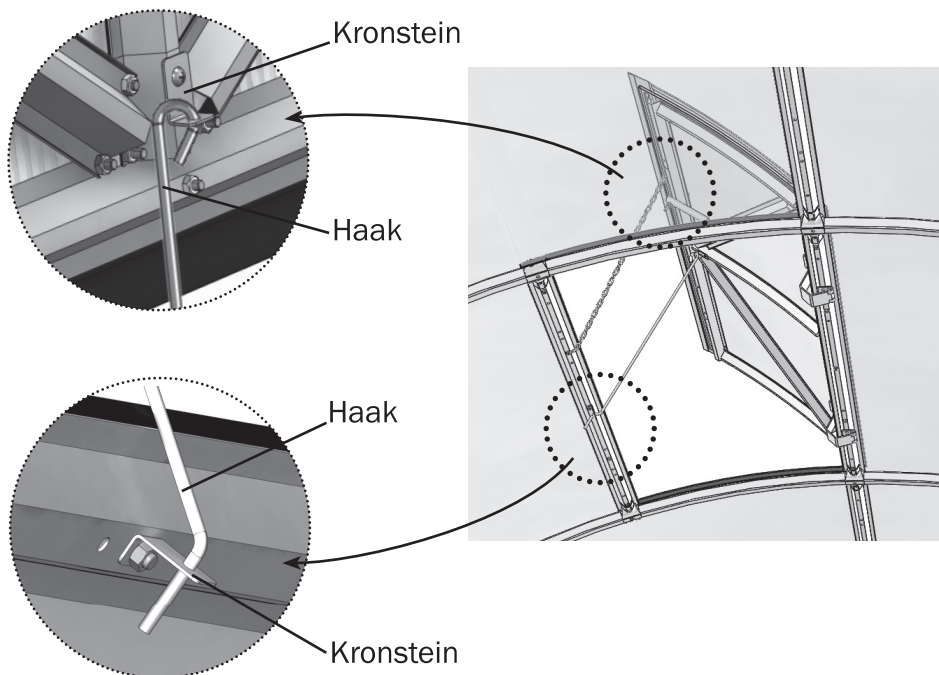

Kvaliteedijuhtimissüsteem (CMK)
OÜ Volja (ООО «Воля») on
sertifitseeritud vastavalt standardi
ISO 9001:2008
nõuetele



Vene Registri pool
sertifitseeritud



**Sigma-kasvuhoonetele
kaarte sammuga 1 m**

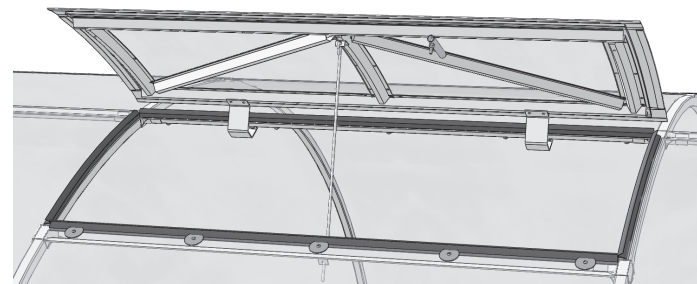

TEHNILINE PASS

lk. 2-3

PAIGALDUSJUHEND

lk. 4-12

Kirjeldus



Õhuakna paigaldus ja kasutamine peavad rangelt toimuma vastavalt tehnilises passis esitatud juhistele ja kasutuseeskirjadele. Tehniline pass tuleb alles hoida.

Õhuaken on mõeldud kasvuhoonete õhutamiseks. Paigaldatakse Sigma-kasvuhoonele kaarte sammuga 1 m. Õhuakna karkass on valmistatud tsingitud terasest ning paigaldatakse kruvide ja mutrite abil. Õhuaken kaetakse kasvuhoonelt väljalõigatud polükarbonaadiga. Õhuaknakomplekt sisaldab kõiki vajalikke kinnituselemente.

Garantiikohustused

1. Tootja vastutab kasvuhoone komplektisuse eest.
2. Tootja vastutab õhuakna kokkupandavuse eest vastavalt juhendile.
3. Nõuete esitamise tähtaeg on 12 kuud alates ostukuupäevast.

Garantiitingimused

- Garantii ei kehti järgmistel juhtudel:
1. õhuakna paigaldamine juhiste eirates
 2. kasutuseeskirjade rikkumine
 3. orkaanid, muud loodusõnnetused

Detailide komplekt





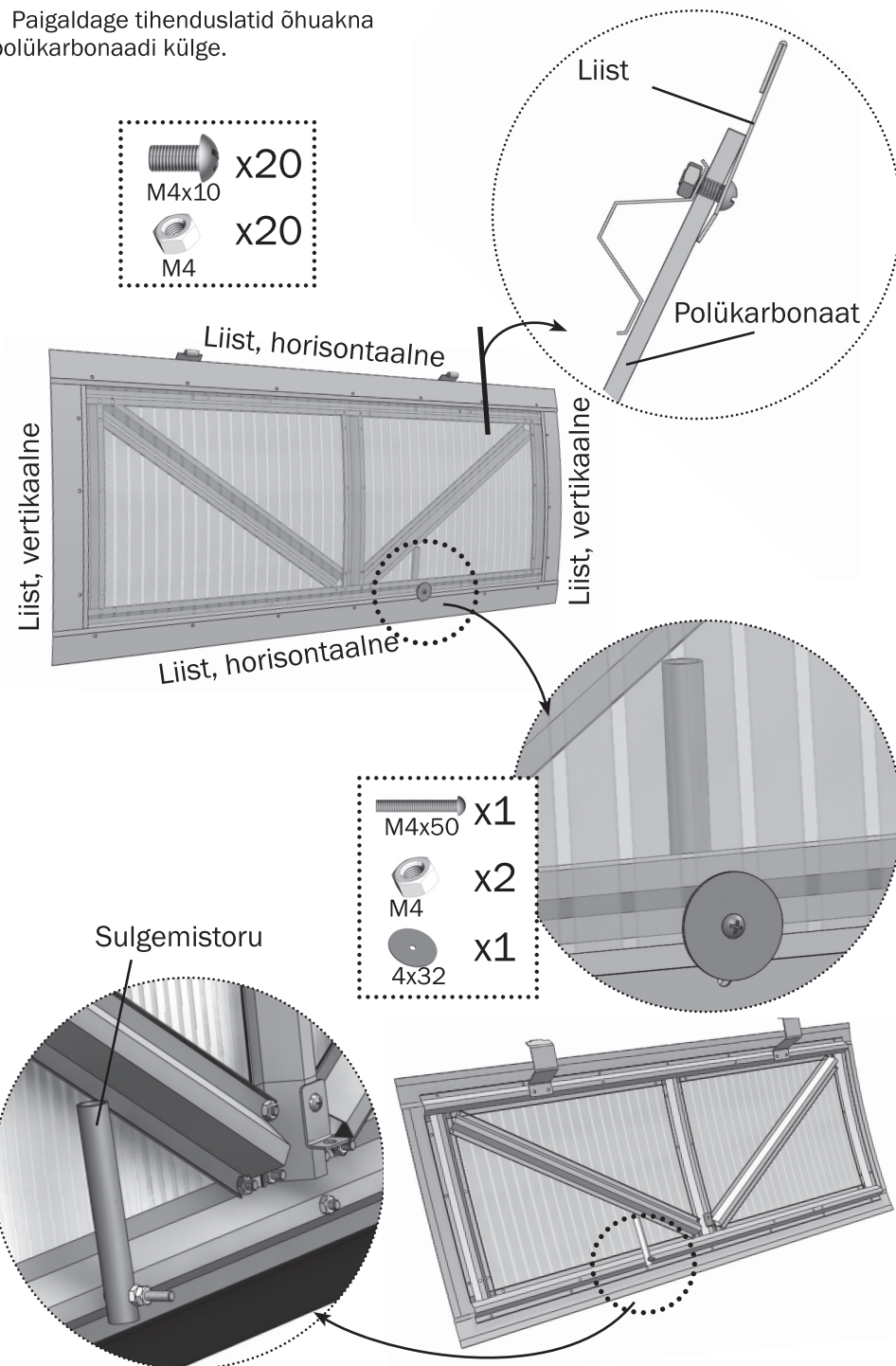



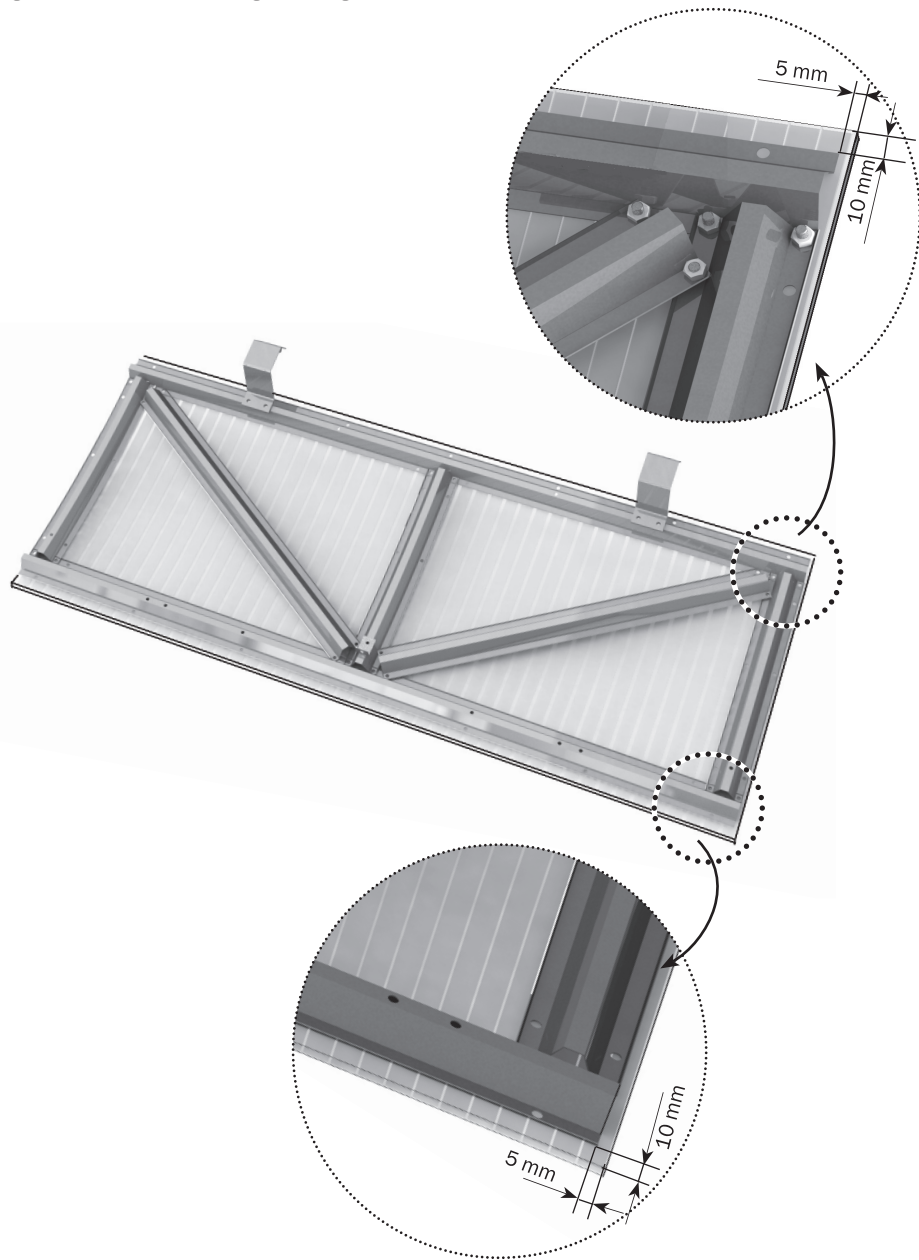





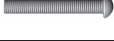

1. kott					
Nõ	markeering	nimetus		pikkus, m	kogus, tk
1	C.02		Latt	0,98	1
2	1		Pikidetail	0,95	2
3	2		Kaar	0,29	3
4	3		Diagonaal	0,49	2
5	-		Liist, vertikaalne	0,33	2
6	-		Liist, horisontaalne	0,1	2
7	-		Haak	0,29	1
8	-		Ava tihend	0,98	2
				0,41	2

Paigaldage tihenduslatid õhuakna polükarbonaadi külge.



Asetage väljalõigatud polükarbonaaditükk õhuakna kokkupandud karkassile ja lõigake piki kontuuri, jälgides tagasiastet.



2. kott			
Nº	nimetus		kogus, tk
1		Otspinna suruk	2
2		Sulgemistoru	1
3		Kronstein	2
4		Seib 4x32	11
5		Kruvi M4x8	31
6		Kruvi M4x10	20
7		Kruvi M4x35	10
8		Kruvi M4x50	1
9		Kruvi M5x45	2
10		Isepuuriv kruvi 4,8x19	6
11		Mutter M4	63
12		Stopperseib M5	2
13		Hing, ülemine	2
14		Hing, alumine	2
15		Kett	1
16		Teip 25 mm	1

Valmistusaeg:

Tootja: OOO «Volja»
 141983, Dubna, Moskovskaja obl., per. Severnyi 8.
 Tootja vastutab toote kvaliteedi eest vastavalt VF tsiviilseadustikule.
 Ettevõtte jätab endale õiguse teha õhuakna konstruktsioonis muudatusi.

Paigaldage kaartele otspinna surukid, painutades neid piki kaart.

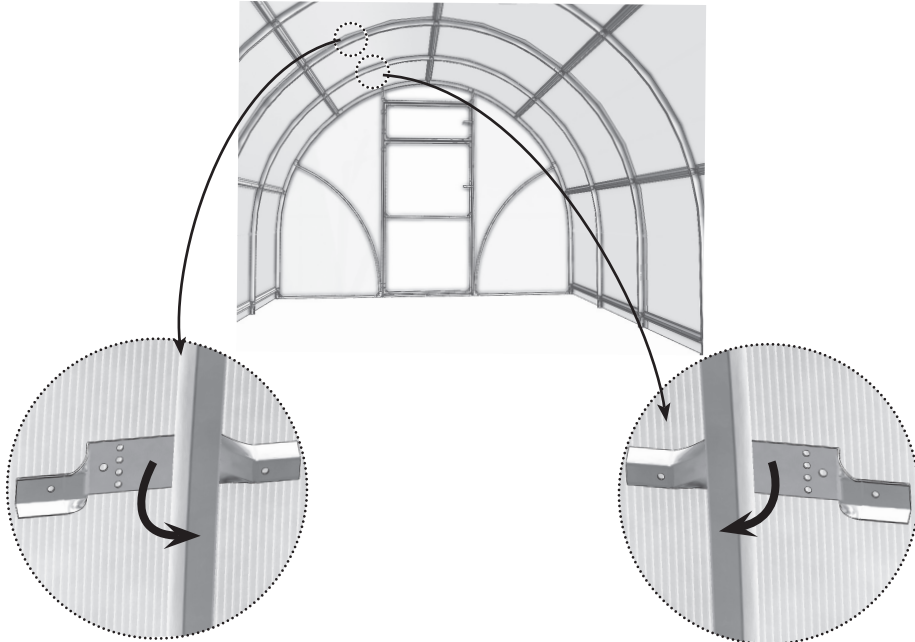

Kinnitage surukid isepuurivate kruvide abil. Paigaldage surukitesse latt **C.02**.

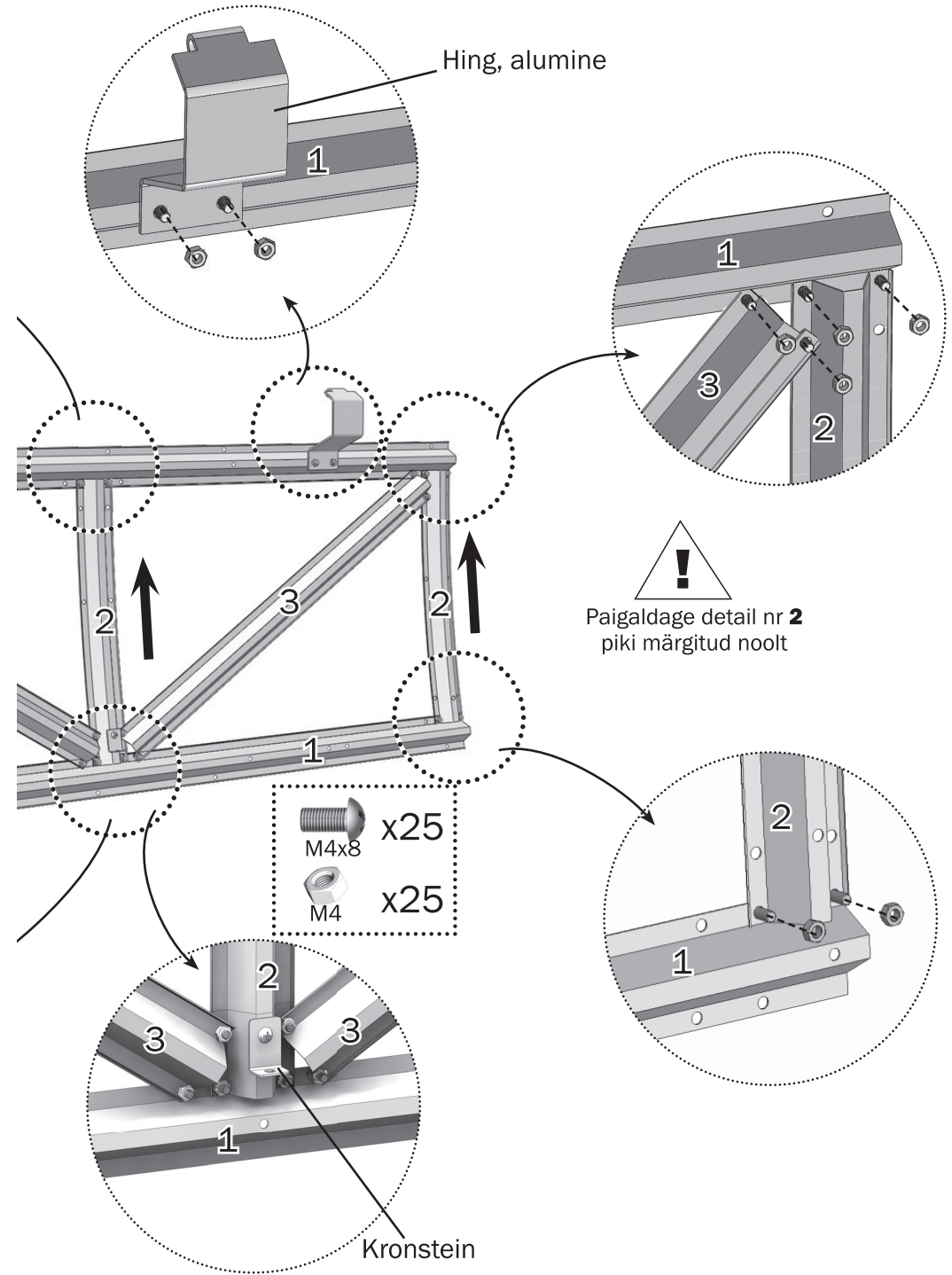
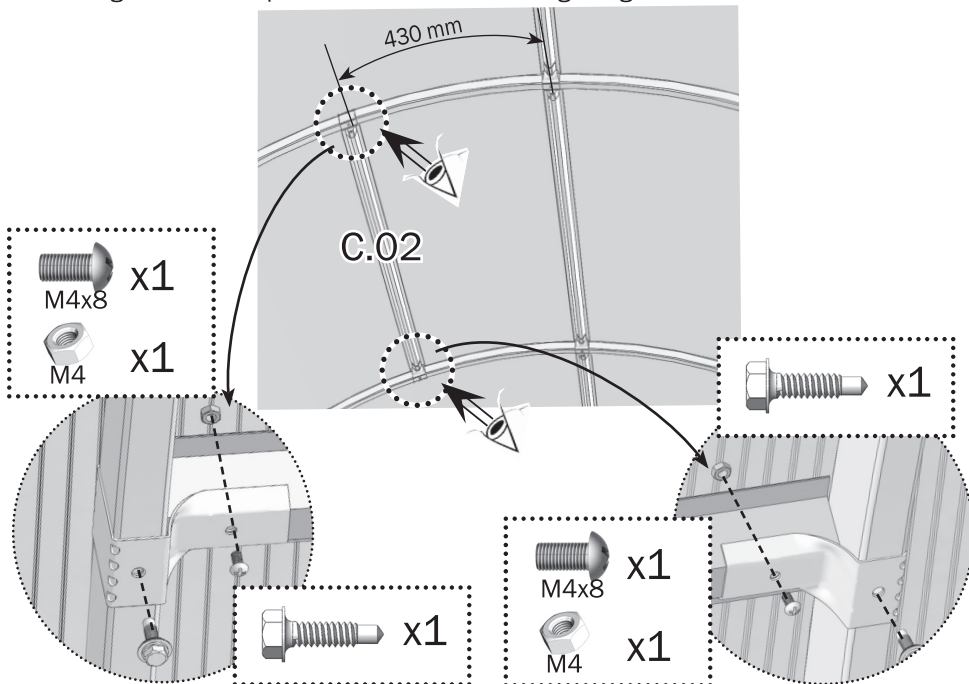

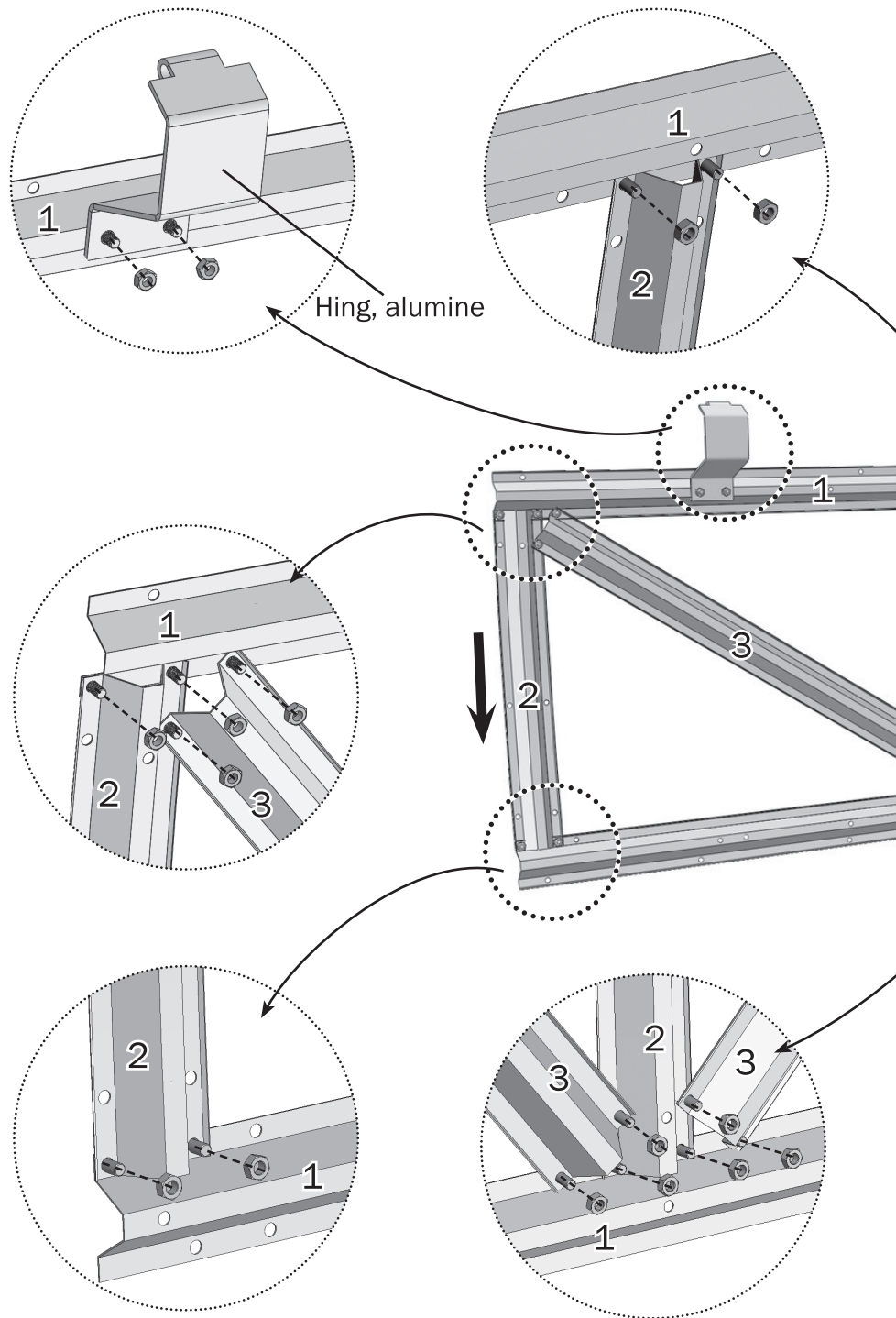

Lõigake polükarbonaat välja piki karkassi ava sisemist kontuuri.

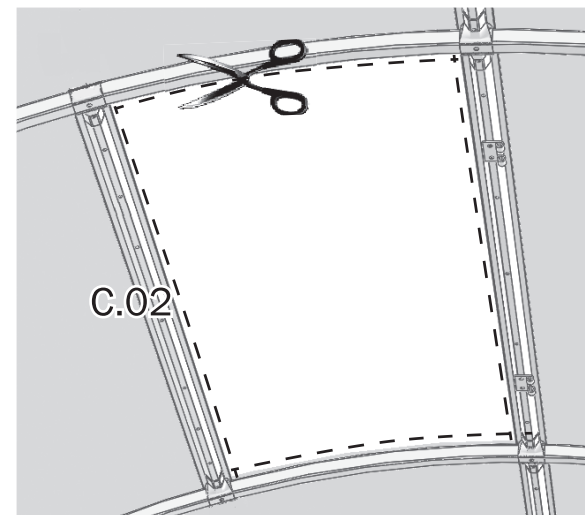

Puurige 4 ava hinge alla ülemisel latil, kinnitades detaili **1** ja joondades selle lati keskel.

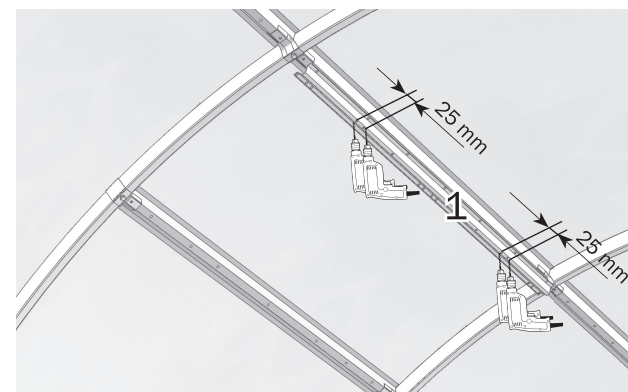

Paigaldage ülemised hinged ülemisele latile.

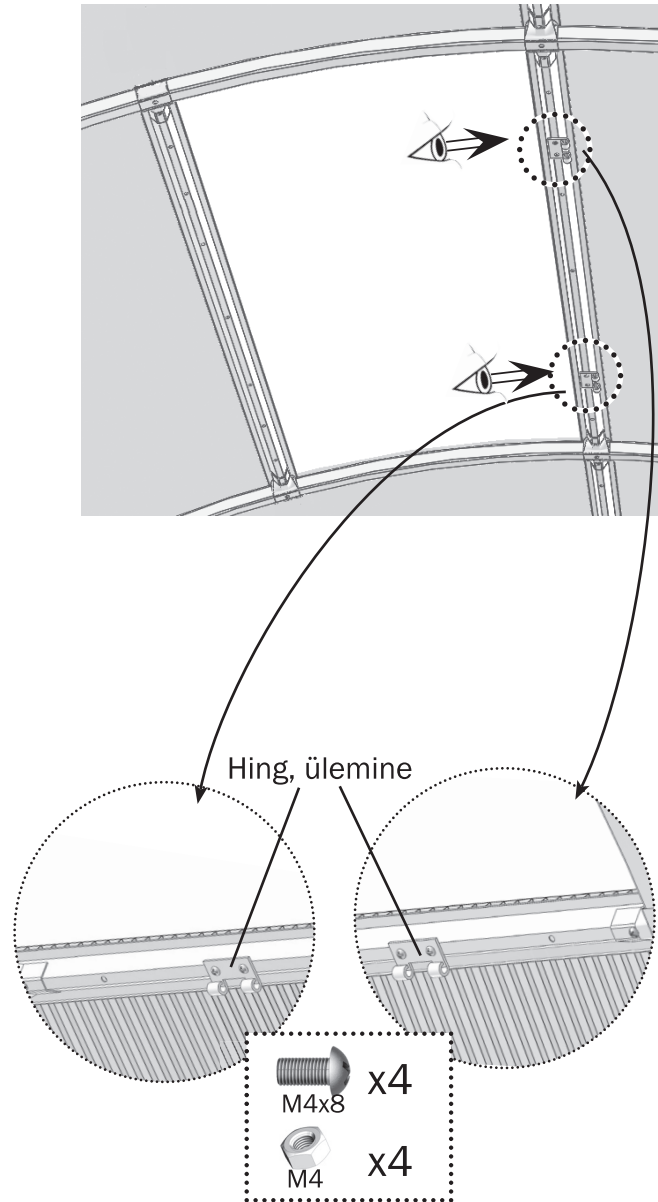

Paigaldage ava tihend piki kasvuhoone väljalõikeperimeetrit, asetades selle polükarbonaadi lõikepinna. Vihmavee ärajuhtimiseks tuleb ülemise tihendi servad jätta väljalõike kontuuridest väljapoole. Selleks lõigake ära tihendi väljaulatava serva jäik osa.

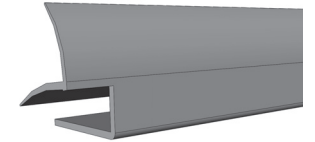

Paigaldage piki väljalõike horisontaalserva mutrite ja seibiga kruvid, olles eelnevalt lattidesse puurinud avad, aga kaartele - isepuurivad kruvid.

